



INSTRUCTION MANUAL

UHF TRANSCEIVER

IC-F4029SDR

Icom Inc.



IMPORTANT

READ ALL INSTRUCTIONS carefully and completely before using the transceiver.

SAVE THIS INSTRUCTION MANUAL — This instruction manual contains important operating instructions for the **IC-F4029SDR UHF TRANSCEIVER**.

EXPLICIT DEFINITIONS

WORD	DEFINITION
⚠ WARNING	Personal injury, fire hazard or electric shock may occur.
CAUTION	Equipment damage may occur.
NOTE	If disregarded, inconvenience only. No risk of personal injury, fire or electric shock.

Icom, Icom Inc. and the  ICOM logo are registered trademarks of Icom Incorporated (Japan) in the United States, the United Kingdom, Germany, France, Spain, Russia and/or other countries.

All other products or brands are registered trademarks or trademarks of their respective holders.

PRECAUTIONS

⚠ CAUTION! NEVER hold the transceiver so that the antenna is very close to, or touching exposed parts of the body, especially the face or eyes, while transmitting. The transceiver will perform best if the microphone is 5 to 10 cm away from the lips and the transceiver is vertical.

⚠ CAUTION! NEVER operate the transceiver with a headset or other audio accessories at high volume levels.

⚠ CAUTION! NEVER short the terminals of the battery pack.

DO NOT push PTT when not actually desiring to transmit.

AVOID using or placing the transceiver in direct sunlight or in areas with temperatures below -25°C or above $+55^{\circ}\text{C}$.

The basic operations, transmission and reception of the transceiver are guaranteed within the specified operating temperature range. However, the LCD display may not be operate correctly, or show an indication in the case of long hours of operation, or after being placed in extremely cold areas.

DO NOT modify the transceiver for any reason.

Optional unit installation should be done at authorized Icom service center only.

KEEP the transceiver from the heavy rain, and **Never** immerse it in the water. The transceiver construction is **water resistant**, not waterproof.

The use of non-Icom battery packs/chargers may impair transceiver performance and invalidate the warranty.

TABLE OF CONTENTS

IMPORTANT	i
EXPLICIT DEFINITIONS	i
PRECAUTIONS	i
TABLE OF CONTENTS	ii
1 ACCESSORIES	1–2
■ Supplied accessories	1
■ Accessory attachments	1
2 PANEL DESCRIPTION	3–8
■ Front panel	3
■ Function display	5
■ Programmable function keys	6
3 BASIC OPERATION	9–11
■ Receiving and transmitting	9
■ Lock function	10
■ Monitor function	10
■ All channel mode and Select channel mode	10
■ Select channel setting	11
■ “My Name” function	11
■ Battery type selection	11
4 SCAN OPERATION	12–13
■ Scan types	12
■ Scan list setting	12
■ Starting a scan	13
5 RINGER FUNCTION (Analog mode operation only)	14–15
■ Smart-Ring operation	14
■ Call-Ring operation	15
■ Auto channel function	15
6 TONE SQUELCH OPERATION	
(Analog mode operation only)	16–18
■ Operation	16
■ Tone scan operation	18
7 DIGITAL OPERATION	19–24
■ Transmitting a call	19
■ Receiving a call	20
■ Ringer operation	20
■ Break-in request call	21
■ Status message	23
■ Digital mode indication	24
8 SET MODE	25–28
■ Set mode programming	25
■ Set mode items	26
9 BATTERY CHARGING	29–33
■ Caution	29
■ Battery chargers	31
10 BATTERY CASE	34
■ Optional battery case (BP-240)	34
11 SWIVEL BELT CLIP	35–36
■ MB-93 contents	35
■ To attach	35
■ To detach	36
12 SPECIFICATIONS	37–39
■ Specifications	37
■ Channel frequency lists	38
13 OPTIONS	40
14 DOC	41–42
15 ABOUT VOICE CODING TECHNOLOGY	43

■ Supplied accessories

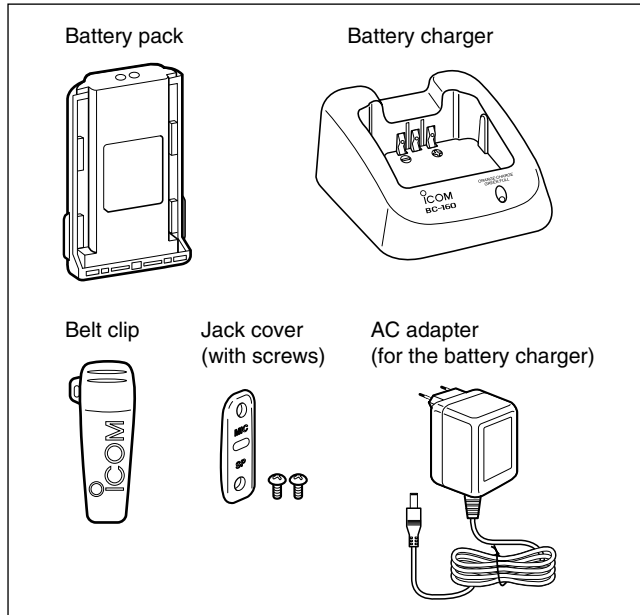

■ Accessory attachments

◇ Battery pack

To attach the battery pack:

Slide the battery pack in the direction of the arrow (❶), then lock it with the battery release button.

- Slide the battery pack until the battery release button makes a 'click' sound.

To release the battery pack:

Slide the battery release button in the direction of the arrow (❷) as shown below. The battery pack is then released.

⚠ **NEVER** release or attach the battery pack when the transceiver is wet or soiled. This may result water or dust getting into the transceiver/battery pack and may result in the transceiver being damaged.

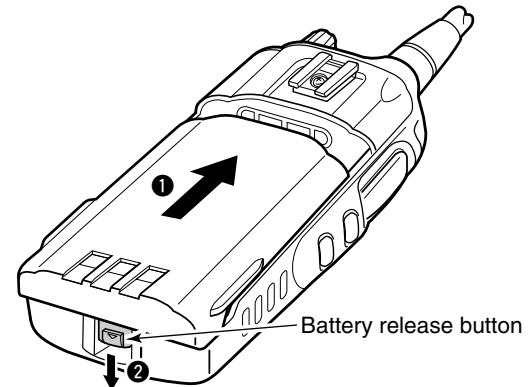

◇ Belt clip

To attach the belt clip:

- ① Release the battery pack if it is attached.
- ② Slide the belt clip in the direction of the arrow until the belt clip is locked and makes a 'click' sound.

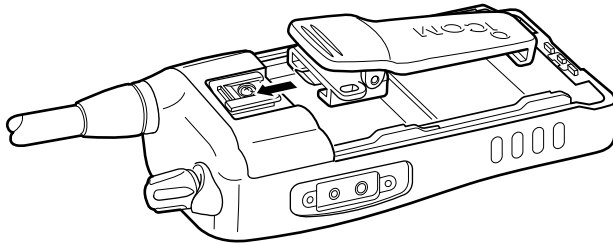

To detach the belt clip:

- ① Release the battery pack if it is attached.
- ② Pinch the clip (1), and slide the belt clip in the direction of the arrow (2).

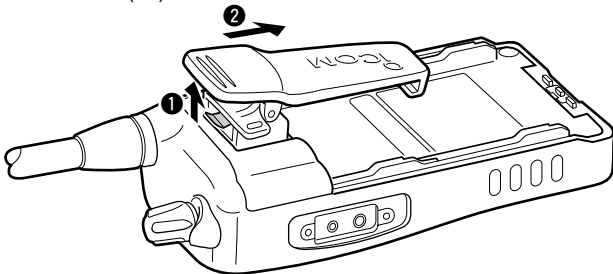

◇ Jack cover

Attach the jack cover when the optional speaker-microphone or headset is not used.

To attach the jack cover:

- ① Insert the jack cover into the [MIC/SP] jack.
- ② Tighten the screws.

To detach the jack cover:

- ③ Unscrew the screws using a phillips screwdriver.
- ④ Detach the jack cover for the optional speaker-microphone or headset connection.

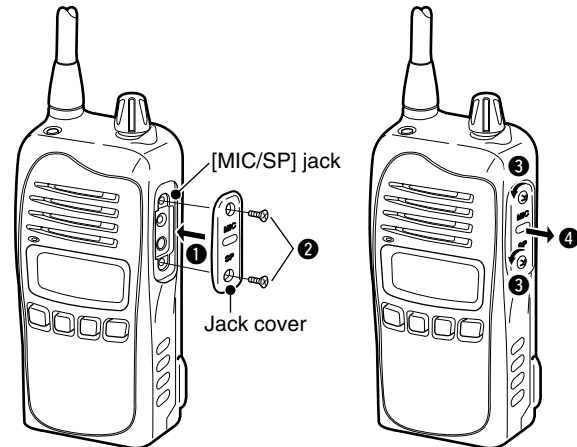

■ Front panel

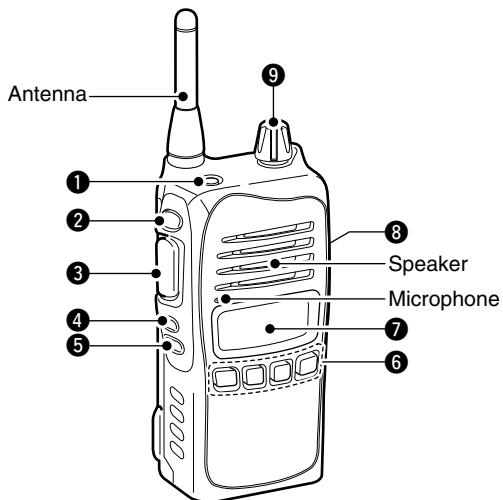

1 TOP SWITCH (Default: LOCK)

Push and hold for 1 sec. to toggle the key lock function ON and OFF.

• Desired function can be programmed by your dealer. (p. 6)

2 SIDE 1 KEY (Default: MONITOR/CODE)

Analog mode operation: [MONI]

Mute and release the CTCSS (DTCS) squelch mute. Open any squelch/deactivate any mutes after pushing and holding this key.

Digital mode operation: [CODE]

Push to display the programmed Common ID, then push [Side2] (CH Up)/[Side3] (CH Down) to select the desired ID.

• Desired function can be programmed by your dealer. (p. 6)

3 PTT SWITCH [PTT]

Push and hold to transmit; release to receive.

4 SIDE 2 KEY (Default: CH UP)

5 SIDE 3 KEY (Default: CH DOWN)

➤ Push to select an operating channel.

➤ Push to select the desired CTCSS/DTCS tone after pushing [CODE]. (During Analog channel operation)

➤ Push to select the desired Common ID after pushing [Side1] (CODE). (During Digital channel operation)

➤ Push to select a TX status message after pushing  (SELECT). (During Digital channel operation)

➤ Push to select the set mode contents in user set mode.

➤ Push to select a scan group after pushing and holding [Scan A Start/Stop]/[Scan B Start/Stop].

• Desired functions can be programmed independently by your dealer. (p. 6)

6 DEALER-PROGRAMMABLE KEYS (Ⓢ / ⓘ / Ⓜ / Ⓞ)

The following functions are assigned to each programmable key as the default.

Analog mode operation:

- Ⓢ ; S-Ring/Ringer : Push to send a Smart-Ring call.
Push and hold to send a Call-Ring.
- ⓘ ; Zone : Push this key, then change the zone up or down using [Side2] (CH Up)/[Side3] (CH Down).
- Ⓜ ; A/S : Push to toggle All and Select channel mode.
- Ⓞ ; Null : No function is assigned.

Digital mode operation:

- Ⓢ ; Call : Push to transmit the programmed Common ID code on the selected channel to make a group call.
- ⓘ ; Zone : Push this key, then change the zone up or down using [Side2] (CH Up)/[Side3] (CH Down).
- Ⓜ ; Select : Push to display the TX status message.
- Ⓞ ; Clear : Push to finish the conversation (sending a clear down signal) and return to standby condition.

• Desired functions can be programmed independently by your dealer. (p. 6)

7 FUNCTION DISPLAY (p. 5)

Displays a variety of information, such as an operating channel number/name, CTCSS frequency, the status message, etc.

8 EXTERNAL MICROPHONE/SPEAKER JACK

Connect the optional speaker-microphone or headset.

NOTE: Connect or disconnect the optional equipment after the transceiver is turned OFF.



Jack cover

NOTE: Attach the jack cover when the equipment is not used. (See p. 2 for details)

9 VOLUME CONTROL [VOL]

Rotate to turn the power ON/OFF and adjusts the audio level.

NOTE: The default setting is used in this instruction manual for description.

2 PANEL DESCRIPTION

■ Function display

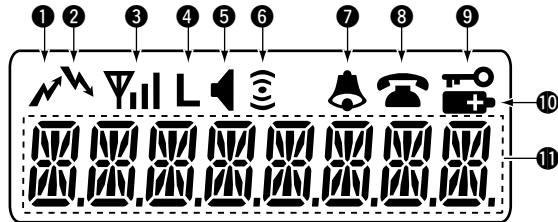

❶ TRANSMIT INDICATOR

Appears while transmitting.

❷ BUSY INDICATOR

Appears while the channel is busy.

❸ SIGNAL STRENGTH INDICATOR

Indicates relative signal strength level.

❹ DRY CELL INDICATOR

Appears during the optional battery case operation. (p. 11)

❺ AUDIBLE INDICATOR

- Appears when the channel is in the 'audible' (unmute) condition. (Analog mode operation only)
- Appears when the matched CTCSS or DTCS code number is received. (Analog mode operation only)
- Appears during communication. (Digital mode operation only)

❻ RINGER INDICATOR

Appears while sending a Smart-Ring call or Call-Ring. (Analog mode operation only)

❼ BELL INDICATOR

- Blinks when the matched Smart-Ring call is received. (Analog mode operation only)
- Blinks when the Ringer call is received. (Digital mode operation only)

❽ CALL CODE INDICATOR

- Appears during in the CTCSS/DTCS tone selection mode. (Analog mode operation only)
- Appears during in the Common ID selection mode. (Digital mode operation only)

❾ KEY LOCK INDICATOR

Appears during the key lock function is ON.

❿ BATTERY INDICATOR

Appears or blinks when the battery power decreases to a specified level.

⓫ ALPHANUMERIC DISPLAY

Displays an operating channel number/name, CTCSS frequency, the status message, etc.

■ Programmable function keys

The desired key function can be assigned to the programmable function keys (Ⓜ, 1, II or ●) in following way.

- ① Select the desired operating mode (Analog or Digital), then turn power OFF.
- ② While pushing and holding [Side3] (CH Down) and the desired key (Ⓜ, 1, II or ●) to be assigned, rotate [VOL] to turn power ON.
 - The selected function name is displayed for a moment.
 - The desired key function is assigned to the pushed key (Ⓜ, 1, II or ●) in the selected operating mode.
- ③ Turn power OFF.
- ④ Repeat steps ② and ③ until the desired key function is selected.

Consult your Icom dealer or system operator for details concerning [Top], [Side1], [Side2] and [Side3] programming.

*Information

Up to two desired functions, one each for Analog and Digital operation mode, can be assigned to [Top], [Side1], [Side2], [Side3], Ⓜ, 1, II and ● keys.

The default setting is used in this instruction manual, for description.

◇ Usable functions

CH UP AND DOWN KEYS

- Push to select an operating channel.
- Push to select the desired CTCSS/DTCS tone after pushing [CODE]. (During Analog mode operation)
- Push to select the desired Common ID after pushing [CODE]. (During Digital mode operation)
- Push to select a TX status message after pushing [SELECT]. (During Digital channel operation)
- Push to change the value or condition in user set mode.
- Push to select the desired scan list from “SCAN 1” or “ZONE” after pushing and holding [Scan A Start/Stop]/[Scan B Start/Stop].

ZONE KEY

Push this key, then change the zone up or down using [CH Up]/[CH Down].

- ▨ **What is “zone”?**— The desired channels are assigned into a zone according to the intended use for grouping. For example, ‘Staff A’ and ‘Staff B’ are assigned into a “Business” zone, and ‘John’ and ‘Cindy’ are assigned into a “Private” zone.

2 PANEL DESCRIPTION

SCAN A START/STOP KEY

- Push to start and cancel scanning operation.
In case of transmission during scan, scanning will be cancelled.
- Push and hold this key for 1 sec. to indicate the scan list, then select the desired scan list from “SCAN 1” or “ZONE” using [CH Up]/[CH Down].

SCAN B START/STOP KEY

- Push to start and cancel scanning operation.
In case of transmission during scan, scanning will be paused. Then resumes after a specified time period has passed after the transmission is finished.
- Push and hold this key for 1 sec. to indicate the scan list, then select the desired scan list from “SCAN 1” or “ZONE” using [CH Up]/[CH Down].

MONI KEY (Analog mode operation only)

Mute and release the CTCSS (DTCS) squelch mute. Open any squelches/deactivate any mutes after pushing and holding this key.

LOCK KEY

- Push and hold for 1 sec. to electronically lock all programmable keys except the following:
[Call]*¹, [Moni]*² and [PTT].
*¹ Digital mode operation only.
*² Analog mode operation only.
- Push and hold for 1 sec. again to turn the lock function OFF.

USER SET MODE KEY

- Push and hold to enter user set mode.
 - During user set mode, push this key to select an item, and change the value or condition using push [CH Up]/[CH Down].
- Push and hold this key again to exit user set mode.

S-RING/RINGER KEY (Analog mode operation only)

- Push to send a Smart-Ring call.
- Push and hold to send a Call-Ring.

CODE KEY

Analog mode operation:

- Push to enter CTCSS/DTCS tone selection mode, then push [CH Up]/[CH Down] to select the desired CTCSS/DTCS tone.
- Push and hold to start the tone scan.

Digital mode operation:

Push to display the programmed Common ID, then push [CH Up]/[CH Down] to select the desired ID.

MY NAME KEY (Analog mode operation only)

Push to display the pre-programmed “My Name” text.

AUTO CH KEY (Analog mode operation only)

Push to start searching for a clear channel.

A/S KEY

Push to toggle All and Select channel mode.
When All channel mode is selected, inhibited channels will be selectable.

CALL KEY (Digital mode operation only)

Push to transmit the programmed Common ID on the selected channel to make a group call.

CLEAR KEY (Digital mode operation only)

Push to finish the conversation (sending a clear down signal) and return to standby condition.

SELECT KEY (Digital mode operation only)

Push to display the status message, then push [CH Up]/[CH Down] to select the desired status message. The first 8-digit of status message is displayed during selection.

BREAK KEY (Digital mode operation only)

Push to transmit a break-in request call.

■ Receiving and transmitting

▨ Prior to using the transceiver for the first time, the battery pack must be fully charged for optimum life and operation. (P. 29)



Receiving:

- ① Rotate [VOL] clockwise to turn the power ON.
- ② Push [Side2] (CH Up) or [Side3] (CH Down) to select the desired operating channel. (pgs. 38, 39)
 - Push **1** (Zone) then push [Side2] (CH Up) or [Side3] (CH Down) to select the desired zone, if required.
 - Setting the CTCSS/DTCS tone code if required. (pgs. 16, 17)
- ③ Listen for a transmission and adjust [VOL] to a comfortable listening level.
 - “” appears when the matched CTCSS or DTCS code number is received.
 - When no transmission is heard, push and hold [Side1] (Moni) while adjusting [VOL]. (Analog mode operation only)

The transceiver is now set to receive desired calls on the selected channel.

Transmitting:

Wait for the channel to become clear to avoid interference.

- ① While pushing and holding [PTT], speak into the microphone at a normal voice level.
 - “” and “” appears.
- ② Release [PTT] to return to receive.

▨ **IMPORTANT:** To maximize the readability of your signal;

1. Pause briefly after pushing [PTT].
2. Hold the microphone 5 to 10 cm (2 to 4 inches) from your mouth, then speak into the microphone at a normal voice level.

◇ **Transmitting notes**

• **Transmit inhibit function**

The transceiver has several inhibit functions which restrict transmission under the following conditions:

- The channel is in mute condition ('Inaudible' condition; “” does not appear.)
- The channel is busy.
- Un-matched (or matched) CTCSS is received. (Depending on the pre-setting.)
- The selected channel is a 'receive only' channel.
- Transmission is inhibited only while receiving a signal with the signal strength is stronger than "RSSI L0 (-105 dBm)" level including a matched Common ID.*

*Digital mode operation only.

• **Time-out timer**

After continuous transmission for the pre-programmed time period, the time-out timer is activated, causing the transceiver to stop transmitting.

• **Penalty timer**

Once the time-out timer is activated, transmission is further inhibited for a period determined by the penalty timer.

Lock function

The lock function provides accidental channel changes and function access.

- Push [Top] (LOCK) for 1 sec. to toggle the lock function ON and OFF.
 - (Call)*1, [Side1] (Moni)*2 and [PTT] are available while the lock function is ON.
 - “” appears.
- *1 Digital mode operation only.
- *2 Analog mode operation only.

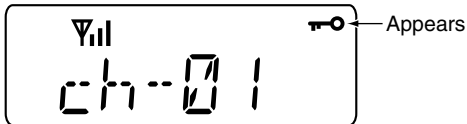

Monitor function

This function is used to listen to weak signals or to open the tone squelch manually. (Analog mode operation only)

- Push and hold [Side1] (Moni) to monitor the operating channel.
 - “” appears.

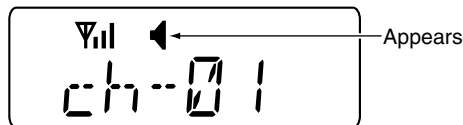

All channel mode and Select channel mode

The transceiver has 2 indication mode— All channel mode and Select channel mode.

Select channel mode provides easy, fast channel selection and speeds up the scan interval. Non select channels are not displayed while in Select channel mode.

- Push [A/S] to toggle All channel mode and Select channel mode.
 - “ALL” or “SELECT” is displayed for about 1 sec. when All or Select channel mode is selected. After indication, return to the standby condition.

All channel mode



Select channel mode

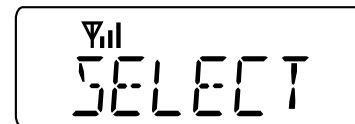

3 BASIC OPERATION

■ Select channel setting

For Select channel mode operation, add the desired channels as 'Select channels' or clear the unwanted channels (Non-select channels).

- ① Push [A/S] to select All channel mode.
- ② Push [Side2] (CH Up) or [Side3] (CH Down) to select the desired channel.
- ③ Push [A/S] for 1 sec. to toggle the channel between 'Select channel' and 'Non-select channel.'

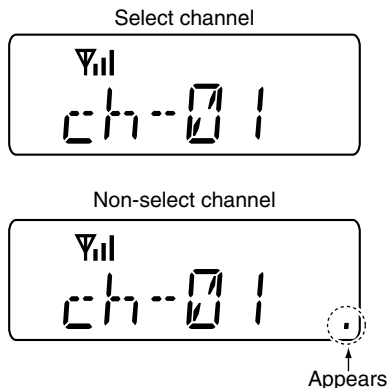

■ “My Name” function

The transceiver displays up to 8-character its name (or a comment) when turning power ON and when the [My Name] is pushed. (Analog mode operation only)

Ask your dealer for name programming details.

- ➔ While pushing and holding [My Name], the pre-programmed name or a comment is displayed.

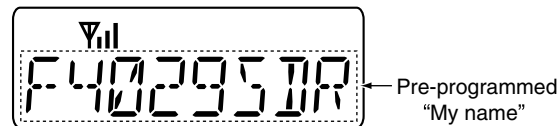

■ Battery type selection

The battery type must be selected according to the attaching battery type when turning the transceiver ON.

Ask your dealer for details.

- ① Turn the power OFF.
- ② While pushing and holding [Top] and [PTT], rotate [VOL] to toggle the attaching battery type.
 - After the display appears, release [TOP] and [PTT].
 - “DRY BATT” is displayed for about 3 sec. then “L” appears when the battery case operation is selected. In this case, the transmit output power is low.
 - “LI-ION” is displayed for about 3 sec. when the Lithium-ion battery operation is selected.

■ Scan types

Scanning is an efficient way to locate signals quickly over all channel.

Setting 'Select channels' (p. 11) and using Select channel mode (p. 10) speeds up the scanning interval.

In addition, repeatedly scanning all zone channels or selected zone channels can be selected.

SCAN in All channel mode

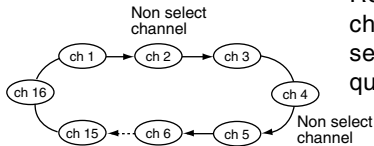

Repeatedly scans all channels including Non select channels in sequence.

SCAN in Select channel mode

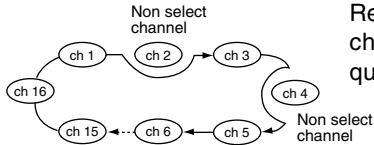

Repeatedly scans select channels only, in sequence.

■ Scan list setting

2 scanning lists ("SCAN 1" and "ZONE") are available for wide variety and flexible scanning operation.

SCAN1

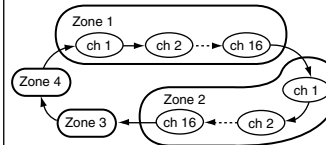

Repeatedly scans all zone channels.

ZONE

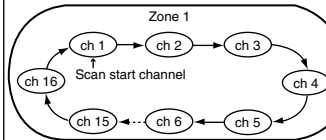

Repeatedly scans the zone that includes the scan start channel.

- ① Push [Scan A] or [Scan B] for 1 sec. to indicate the scan list, then select the desired scan list from "SCAN 1" or "ZONE" using [Side2] (CH Up)/[Side3] (CH Down).
- ② Push [Scan A] or [Scan B] to return to the standby condition.

4 SCAN OPERATION

■ Starting a scan

To speed up the scanning interval, set the desired channels as 'Select channels' and set Select channel mode in advance. (pgs. 10, 11)

- ① Push [Scan A] or [Scan B] to start scanning.
- ② When a signal is received, scan pauses and resumes according to the included CTCSS frequency or DTCS code. (pgs. 16, 17)
 - When the code is matched, scan resumes 3 sec. after the signal disappears.
 - When the code is not matched, scan resumes immediately.
- ③ Push [Scan A] or [Scan B] to stop scanning.

Starting "Scan 1".

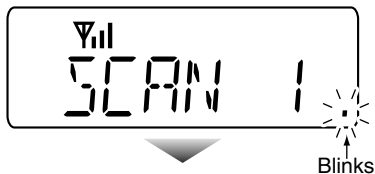



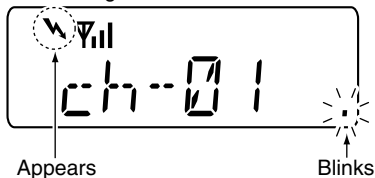

When a signal is received.



Smart-Ring operation

The ring function has an answer back feature. This allows you to confirm whether or not a call has reached the member of your group even if the operator is temporarily away from the transceiver.

- ① Set the same operating channel and CTCSS tone code for all of your group transceivers.
- ② Push  (S-Ring/Ringer) to send the Smart-Ring call.
 - “” and “” appears.
 - When a member of your group station answers your call, the transceiver emits beep tones for every 10 sec. and “” blinks.
 - Push [Side1] (MONI) to cancel the Ringer beep and “” blinks.
 - When no answer comes back, the transceiver emits short failure beep tones.

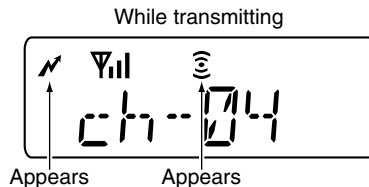

- ③ Push [PTT] to answer the call and to stop the beeps and blinking.

NOTE: This function is available only when the called station has use the same CTCSS tone code and the same operating channels as you.

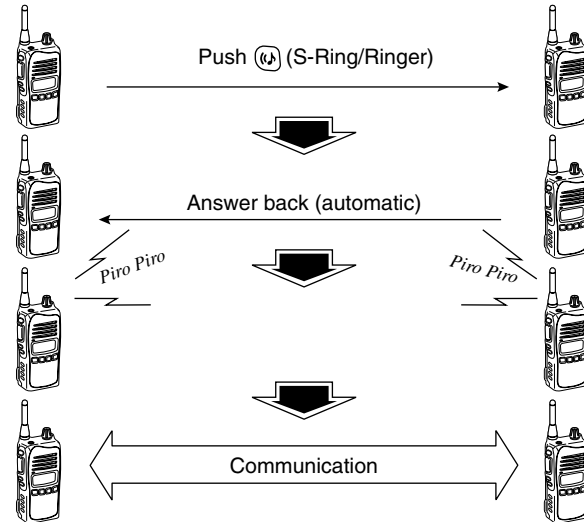

5 RINGER FUNCTION (Analog mode operation only)

■ Call-Ring operation

- ① Set the same operating channel and CTCSS tone code for all of your group transceivers.
- ② Push and hold (S-Ring/Ringer) to send the pre-selected ring tone to your group members.
 - “ \mathcal{M} ” and “ \mathcal{E} ” appears.
 - The ring tone* is emitted while (S-Ring/Ringer) is pushed and held.
 - The same ring tone comes from your group station's speaker.

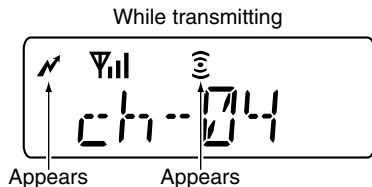

* The Call-Ring emission type can be selected in Set mode. (p. 27)

■ Auto channel function

The auto channel function automatically searches a clear channel during scan when (S-Ring/Ringer) is pushed. Then, the ringer tone is transmitted for a specified period in the founded clear channel. Another station during scanning may answer the call in the clear channel if it receives the ringer signal.

- ① Push [Auto Ch] to start scan.
 - The selected scan type and scan list are available. (pgs. 10, 12)
- ② To call a waiting station, push (S-Ring/Ringer) for 1 sec. to transmit a ringer tone.
 - The auto channel function automatically searches a clear channel. After a clear channel found, a ringer tone is transmitted.
 - To call a waiting station by voice, push [PTT] until beep tones sound (for longer than the ringer time), then speak into the microphone.
- ③ The auto channel function restarts 30 sec. later after a busy signal disappears and in which no operation is performed while the auto channel function is in use.
- ④ Push [Auto Ch] to cancel the function.

5 TONE SQUELCH OPERATION (Analog mode operation only)

6

■ Operation

By default, the transceiver uses a CTCSS/DTCS squelch system. The CTCSS tone squelch. DTCS opens only when receiving a signal containing a matching tone. You can silently wait for calls from group members using the same tone.

◇ CTCSS tone setting

The transceiver is equipped with 50 CTCSS tones. CTCSS operation provides communication with silent standby since you will only receive calls from group members using the same CTCSS tone frequency.

- ① Rotate [VOL] to turn the power ON.
- ② Push [Side2] (CH Up) or [Side3] (CH Down) to select the desired channel. (pgs. 38, 39)
- ③ Push [Code] to enter the CTCSS tone frequency selection mode.
 - “☎” appears.
 - Push [Code] for 1 sec. to toggle the CTCSS tone and DTCS code selection mode.
 - The error beep is emitted in no tone setting channel. The tone code setting is not available in the channel.
- ④ Push [Side2] (CH Up) or [Side3] (CH Down) to select the desired tone code.
- ⑤ Push [Code] again to set.
- ⑥ When the received signal includes a matching tone, squelch opens and the signal can be heard.
 - When the received signal’s tone does not match, tone squelch does not open.
 - To open the squelch temporarily, push [Side1] (MONI).

• Available CTCSS tone frequency (Hz)

No.	Freq.	No.	Freq.	No.	Freq.	No.	Freq.	No.	Freq.
01	67.0	11	94.8	21	131.8	31	171.3	41	203.5
02	69.3	12	97.4	22	136.5	32	173.8	42	206.5
03	71.9	13	100.0	23	141.3	33	177.3	43	210.7
04	74.4	14	103.5	24	146.2	34	179.9	44	218.1
05	77.0	15	107.2	25	151.4	35	183.5	45	225.7
06	79.7	16	110.9	26	156.7	36	186.2	46	229.1
07	82.5	17	114.8	27	159.8	37	189.9	47	233.6
08	85.4	18	118.8	28	162.2	38	192.8	48	241.8
09	88.5	19	123.0	29	165.5	39	196.6	49	250.3
10	91.5	20	127.3	30	167.9	40	199.5	50	254.1

/// **NOTE:** The indication type (during in CTCSS and DTCS selection mode) can be selected from code and number. (p. 28)

5

6

6 TONE SQUELCH OPERATION (Analog mode operation only)

◆ DTCS code setting

This transceiver is equipped with 84 DTCS codes. DTCS operation provides communication with silent standby since you will only receive calls from group members using the same DTCS code number.

- ① Rotate [VOL] to turn the power ON.
- ② Push [Side2] (CH Up) or [Side3] (CH Down) to select the desired channel.
- ③ Push [Code] to enter the DTCS code selection mode.
 - “☎” appears.
 - Push [Code] for 1 sec. to toggle the DTCS code and CTCSS tone selection mode.
 - The error beep is emitted in no tone setting channel. The tone code setting is not available in the channel.
- ④ Push [Side2] (CH Up) or [Side3] (CH Down) to select the desired tone code.
- ⑤ Push [Code] again to set.
- ⑥ When the received signal includes a matching tone, squelch opens and the signal can be heard.
 - When the received signal's tone does not match, tone squelch does not open.
 - To open the squelch temporarily, push [Side1] (MONI).

 **NOTE:** The indication type (during in CTCSS and DTCS selection mode) can be selected from code and number.
(p. 28)

• Available DTCS code list

No.	Code	No.	Freq.	No.	Freq.	No.	Freq.	No.	Freq.
A0	023	B0	065	C0	132	D0	205	E0	271
A1	025	B1	071	C1	134	D1	223	E1	306
A2	026	B2	072	C2	143	D2	226	E2	311
A3	031	B3	073	C3	152	D3	243	E3	315
A4	032	B4	074	C4	155	D4	244	E4	331
A5	036	B5	114	C5	156	D5	245	E5	343
A6	043	B6	115	C6	162	D6	251	E6	346
A7	047	B7	116	C7	165	D7	261	E7	351
A8	051	B8	125	C8	172	D8	263	E8	364
A9	054	B9	131	C9	174	D9	265	E9	365
F0	371	G0	466	H0	627	I0	732		
F1	411	G1	503	H1	631	I1	734		
F2	412	G2	506	H2	632	I2	743		
F3	413	G3	516	H3	654	I3	754		
F4	423	G4	532	H4	662				
F5	431	G5	546	H5	664				
F6	432	G6	565	H6	703				
F7	445	G7	606	H7	712				
F8	464	G8	612	H8	723				
F9	465	G9	624	H9	731				

■ Tone scan operation

This transceiver can detect the CTCSS tone frequency or DTCS code in the received signal. By monitoring a signal that is being transmitted from the other station, you can determine the tone frequency or DTCS code necessary to open a squelch.

This function very useful when you are going to communicate with unknown CTCSS tone or DTCS code number stations. Scans all of the CTCSS tone frequency and DTCS code, then stops when a matched tone code is detected.

- ① Rotate [VOL] to turn the power ON.
- ② Push [Side2] (CH Up) or [Side3] (CH Down) to select the desired channel that you want to assign the CTCSS tone frequency or DTCS code.
- ③ Push [Code] for 1 sec. to start the tone scan.
 - During scanning, push [Code] to stop the scan.

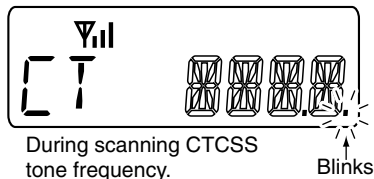



- ④ The tone scan stops when the tone code is detected.
 - During scanning, push [Code] to stop the scan.
 - Scan resumes 3 sec. after the signal disappears.
- ⑤ Push [Code] or [PTT] to determine the tone code number.

■ Transmitting a call

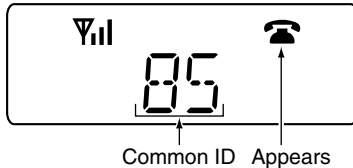

The [Side1] (Code) key toggles between the standby mode and the Common ID selection mode when pushed. During in the ID code selection mode, [Side2] (CH Up) or [Side3] (CH Down) selects the desired Common ID.

- ① While in the standby condition, push [Side1] (Code) to enter the Common ID selection mode.
 - “” appears.



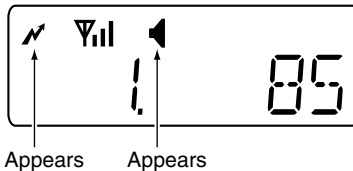

- ② Push [Side2] (CH Up) or [Side3] (CH Down) to select the desired Common ID. Then push [Side1] (Code) to set. (p. 39)
- ③ Push [PTT] to call.
 - “” appears.
 - When a member of your group station answers your call, the transceiver emits beep tones and “” appears.



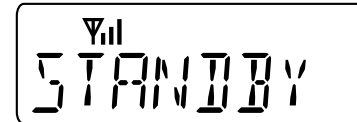



- ④ Push [PTT] to transmit; release to receive.
- ⑤ Push  (Clear) to send the 'Clear down' signal.
 - Either station can send a 'Clear down' signal.
 - “STANDBY” is displayed for 2 sec. (approx.)
 - “” disappears and the transceiver returns to the standby condition.

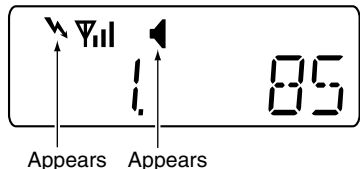

■ Receiving a call

- ① When a call is received;
- “” and “” appears and the mute is released.



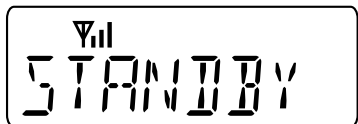

- ② Push and hold [PTT], then speak into the microphone at a normal voice level.
- “” appears.
- /// **NOTE:** Only one station is permitted to speak.
- ③ Release [PTT] to return to receive.
- ④ To finish the conversation, push  (Clear) to send the ‘Clear down’ signal.
- Either station can send a ‘Clear down’ signal.
 - “STANDBY” is displayed for 2 sec. (approx.)
 - “” disappears and the transceiver returns to the standby condition.







■ Ringer operation

Before starting communication, you can send the Ringer call to announce your group station that you are going to transmit.

See p. 14 for details of the ringer procedure.

*  (S-Ring/Ringer) is replaced with  (Call) in the illustration on page 14.

- ① Set the desired Common ID. (pgs. 19, 39)
- ② Push  (Call) to send the Ringer call.
- When a member of your group station answers your call, the received transceiver emits beep tones* and “” appears on either side.
 - “” blinks on the received transceiver.
- * The Ringer emission type can be selected in Set mode. (p. 27)
- ③ Push [PTT] to transmit; release to receive.
- ④ Push  (Clear) to send the ‘Clear down’ signal.
- Either station can send a ‘Clear down’ signal.
 - “STANDBY” is displayed for 2 sec. (approx.)
 - “” disappears and the transceiver returns to the standby condition.
- /// **NOTE:** This function is available only when the called station has use the same Common ID and the same operating channels as you.

■ Break-in request call

The break-in request function allows you to announce to another station that you want to talk.

◇ Transmitting a break-in request call

- ① While receiving an another station's communication, push [Break] to transmit the break-in request call.
 - "FAILED" is displayed when break-in request call is un-succeeded.
- ② Wait for the reply call from the station who receives the break-in request call.
 - "WAIT" is displayed.
 - Pushing  (Clear) cancels the call.

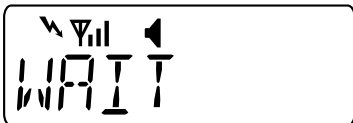

- ③ After receiving the reply call, the break-in request call is completed.
 - "COMPLETE" is displayed.

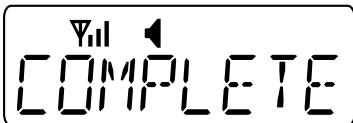

- ④ Push and hold [PTT], then speak into the microphone at a normal voice level.

◇ Receiving a break-in request call

- ① When the break-in request call is received after transmitting, the audio sounds.
 - "BREAK" is displayed.

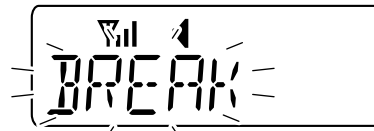

- ② Push [PTT] to transmit the reply call.

• **How to use the break-in request?**

The break-in request call allows you to announce to another station that you want to talk. Another station will receive it after the transmission is finished.

- **Station A, B and C are communicating using the same common ID.**

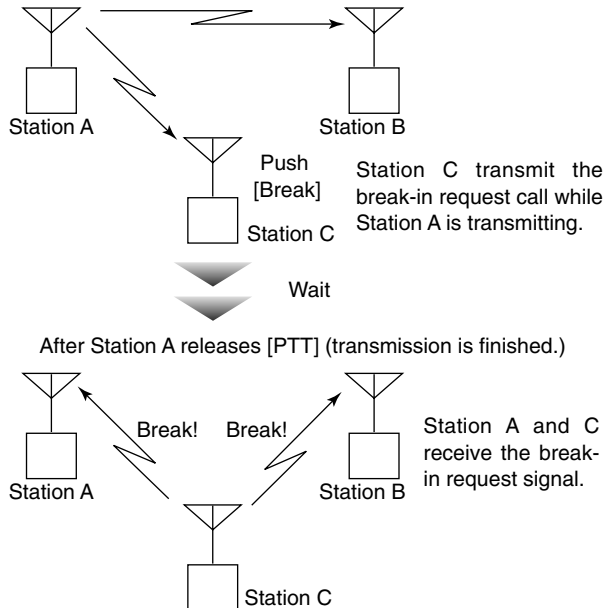

■ Status message

◇ General

The status message can be selected with the programmed text, and the message text is also displayed on the function display of the called station.

Up to 32 status types (1 to 32) are available, and the status messages 30, 31 and 32 have designated meanings.

Status 30: 'CALL HOME'

Status 31: 'URGENT PICKUP'

Status 32: 'RETURN TO BASE'

◇ Transmitting a status

- ① Set the desired Common ID. (pgs. 19 and 39)
- ② Push **[M]** (Select), then push [Side2] (CH Up) or [Side3] (CH Down) to select the desired status message.

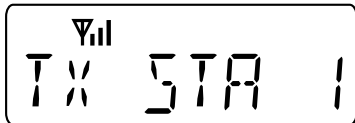

- ③ Push **[CALL]** (Call) to transmit the status message to the selected station/group.
 - "FAILED" is displayed when status call is un-succeeded.
 - The transceiver returns to the standby condition automatically when the transmission is successful.

◇ Receiving a status message

- ① When a status message is received;
 - Beeps sound.
 - The status message displayed.
 - When a status message with more than 9-character is received, the first 8-character and then the remaining characters are displayed alternately.

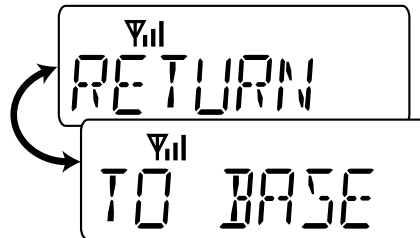

When 15-character status message is received.

- ② Push any key to return to the standby condition.

■ Digital mode indication

The following indications are available for the digital mode operation.

- **BREAK** : Appears when the break-in request call is received.
- **CANCELED** : Appears when the break-in request call is cancelled.
- **COMPLETE** : Appears when the break-in request call is succeeded.
- **FAILED** : Appears when a call (includes status or break-in request call) is un-succeeded.
- **HI VOLT** : Appears when the applied DC power voltage exceeds the specified level.
- **LOCK** : Appears when key (except [PTT]) operation is performed while the lock function is activated.
- **LOW BATT** : Appears when the attached battery pack is nearly exhaustion.
- **STANDBY** : Appears when clear down signal is received.
- **WAIT** : Appears when break-in request call is ready to transmit.

■ Set mode programming

Set mode is used to change the conditions of the transceiver's functions: Backlight, Beep, Beep level, Squelch level*¹, Mic gain, Battery voltage, Signal monitor*¹, Ringer*¹, Ringer2*², Ringer timer*¹, Ringer2 level*², Code type*¹ and Power save.

/// Available functions may differ depending on how they are set by the dealer.

*¹ Appears during in Analog mode operation.

*² Appears during in Digital mode operation.

- ① Turn power OFF.
- ② Push and hold [User Set Mode] to enter the set mode.
- ③ Push [User Set Mode] several times to select the desired item.
- ④ Push [Side2] (CH Up) or [Side3] (CH Down) to select the desired condition of the item.
- ⑤ Push and hold [User Set Mode] to return to the normal operation mode.

◇ Set mode construction

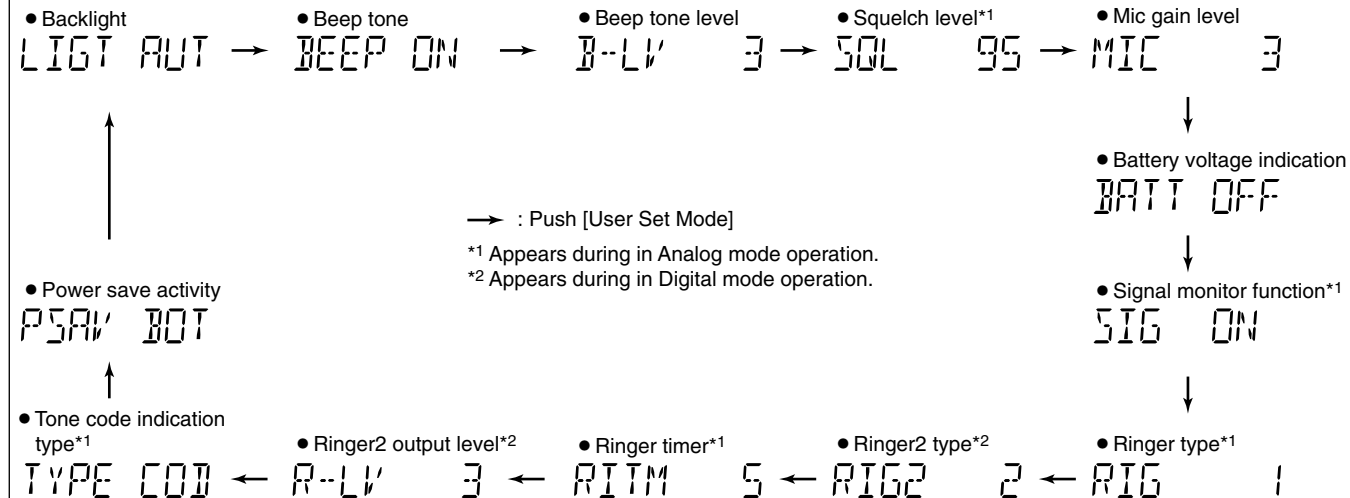

■ Set mode items

◇ Automatic backlighting

This function is convenient for nighttime operation.

- ON : Backlight turns ON continuously.
- OFF : No backlight.
- AUT (Auto) : Backlight turns ON for 5 sec. when any switch except [PTT] is pushed.
- AU2 (Auto2) : Backlight turns ON for 5 sec. when any switch except [PTT] is pushed, or the LCD indication is changed.



Backlight Auto (default)

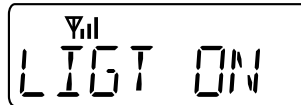

Backlight ON

◇ Beep tone function

You can select the silent operation by turning the beep tones OFF or you can have confirmation beeps sound in both analog and digital mode, digital mode only or analog mode only at the push of a key by turning beeps ON.

The beep tone volume is linked with [VOL].

⚡ **NOTE:** That some beeps, such as the lockout timer and TOT, cannot be turned OFF.

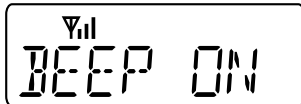

Beep ON (default)

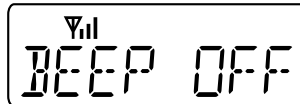

Beep OFF

◇ Beep tone level

Select the key-touch beep minimum output level from 1 to 5. The beep output level is adjustable with [VOL] control.

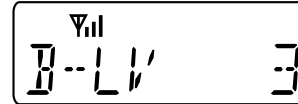

Beep tone level 3 (default)

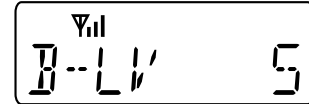

Beep tone level 5

◇ Squelch level

Set the noise squelch threshold level within 0 to 255 range.

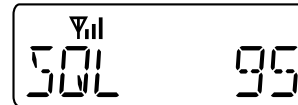

Squelch level 95

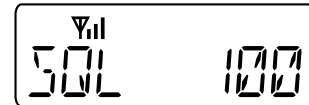

Squelch level 100

◇ Microphone gain level

Select the Mic gain level from 1 (Min) to 5 (Max).

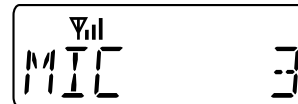

Mic gain level 3 (default)

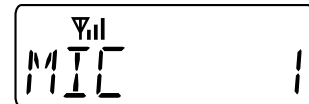

Mic gain level 1 (minimum)

8 SET MODE

◇ Battery voltage indication

Select the Battery voltage indicator function ON and OFF. Battery voltage displays on the LCD display for 2 sec., when the POWER is turned ON.



Battery voltage indication
OFF (default)



Battery voltage indication
ON

◇ Signal monitor function

Select the ringer emission monitor function ON and OFF. The ringer beeps can be heard from the speaker when making a call with ringer function.

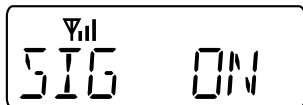

Signal monitor function
ON (default)

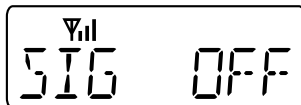

Signal monitor function
OFF

◇ Ringer type

Call-Ring emission type is selectable with 16 different individual sounds.

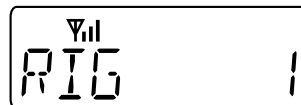

Ringer type 1 (default)

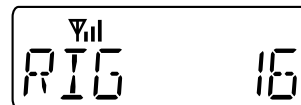

Ringer type 16

◇ Ringer2 type

Ringer emission type for digital mode operation are selectable with 16 different individual sounds and OFF.

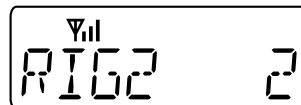

Ringer2 type 2 (default)

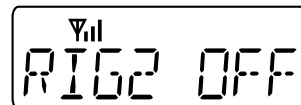

Ringer2 type OFF

◇ Ringer beep emission timer

Enter the time period for ringer beeps emission within 0 to 16 second.

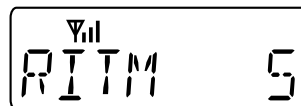

Ringer timer 5 sec. (default)

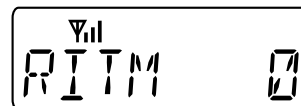

Ringer timer 0 sec. (OFF)

◇ Ringer2 beep output level

Select the ringer 2 beep output level when receiving a call from 1 to 5, or minimum output level from 1 to 5.

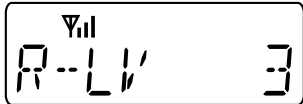

Ringer2 output level 3 (default)

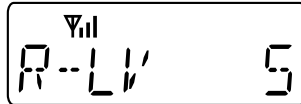

Ringer2 output level 5

◇ Tone code indication type

Select the desired indication type during CTCSS or DTCS selection mode from CTCSS/DTCS code and CTCSS/DTCS channel number.

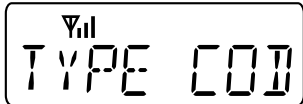

Tone code indication type
Code (default)

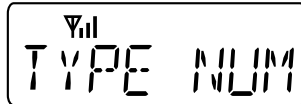

Tone code indication type
Number

◇ Power save

The power save function reduces the current drain to conserve the battery power.

Select the power save function activity in both Analog and Digital mode, Digital mode only or Analog mode only. Or you can select the power save function deactivated.



Power save activity
Both (default)

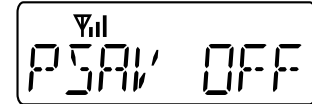

Power save activity
OFF

■ Caution

Misuse of Lithium-ion batteries may result in the following hazards: smoke, fire, or the battery may rupture. Misuse can also cause damage to the battery or degradation of battery performance.

- ⚠ **DANGER!** Use and charge only specified Icom battery packs with Icom radios or Icom charger. Only Icom battery packs are tested and approved for use and charge with Icom radios or Icom charger. Using third-party or counterfeit battery packs or charger may cause smoke, fire, or cause the battery to burst.

◆ Battery caution

- ⚠ **DANGER! DO NOT** hammer or otherwise impact the battery. Do not use the battery if it has been severely impacted or dropped, or if the battery has been subjected to heavy pressure. Battery damage may not be visible on the outside of the case. Even if the surface of the battery does not show cracks or any other damage, the cells inside the battery may rupture or catch fire.

- ⚠ **DANGER! NEVER** use or leave battery packs in areas with temperatures above +60°C. High temperature buildup in the battery, such as could occur near fires or stoves, inside a sun heated car, or in direct sunlight may cause the battery to rupture or catch fire. Excessive temperatures may also degrade battery performance or shorten battery life.
- ⚠ **DANGER! DO NOT** expose the battery to rain, snow, seawater, or any other liquids. Do not charge or use a wet battery. If the battery gets wet, be sure to wipe it dry before using. The battery is not waterproof.
- ⚠ **DANGER! NEVER** incinerate used battery packs since internal battery gas may cause them to rupture, or may cause an explosion.
- ⚠ **DANGER! NEVER** solder the battery terminals or NEVER modify the battery pack. This may cause heat generation, and the battery may rupture, emit smoke or catch fire.
- ⚠ **DANGER!** Use the battery only with the transceiver for which it is specified. Never use a battery with any other equipment, or for any purpose that is not specified in this instruction manual.
- ⚠ **DANGER!** If fluid from inside the battery gets in your eyes, blindness can result. Rinse your eyes with clean water, without rubbing them, and see a doctor immediately.

- **WARNING!** Immediately stop using the battery if it emits an abnormal odor, heats up, or is discolored or deformed. If any of these conditions occur, contact your Icom dealer or distributor.
- **WARNING!** Immediately wash, using clean water, any part of the body that comes into contact with fluid from inside the battery.
- **WARNING! NEVER** put the battery in a microwave oven, high-pressure container, or in an induction heating cooker. This could cause a fire, overheating, or cause the battery to rupture.
- **CAUTION!** Always use the battery within the specified temperature range for the transceiver (-25°C to $+55^{\circ}\text{C}$) and the battery itself (-20°C to $+60^{\circ}\text{C}$). Using the battery out of its specified temperature range will reduce the battery's performance and battery life. Please note that the specified temperature range of the battery may exceed that of the transceiver. In such cases, the transceiver may not work properly because it is out of its operating temperature range.
- **CAUTION!** Shorter battery life could occur if the battery is left fully charged, completely discharged, or in an excessive temperature environment (above $+45^{\circ}\text{C}$) for an extended period of time. If the battery must be left unused for a long time, it must be detached from the radio after discharging. You may use the battery until the battery indicator shows half-capacity, then keep it safely in a cool dry place with the temperature between -20°C to $+25^{\circ}\text{C}$.

◇ Charging caution

- **⚠ DANGER! NEVER** charge the battery pack in areas with extremely high temperatures, such as near fires or stoves, inside a sun heated car, or in direct sunlight. In such environments, the safety/protection circuit in the battery will activate, causing the battery to stop charging.
- **WARNING! DO NOT** charge or leave the battery in the battery charger beyond the specified time for charging. If the battery is not completely charged by the specified time, stop charging and remove the battery from the battery charger. Continuing to charge the battery beyond the specified time limit may cause a fire, overheating, or the battery may rupture.
- **WARNING! NEVER** insert the transceiver (battery attached to the transceiver) into the charger if it is wet or soiled. This could corrode the battery charger terminals or damage the charger. The charger is not waterproof.
- **CAUTION! DO NOT** charge the battery outside of the specified temperature range: BC-160 (0°C to $+45^{\circ}\text{C}$). Icom recommends charging the battery at $+20^{\circ}\text{C}$. The battery may heat up or rupture if charged out of the specified temperature range. Additionally, battery performance or battery life may be reduced.

9 BATTERY CHARGING

■ Battery chargers

▨ **NOTE:** See each instruction manual for details of the charger LED indication, operation, etc.

◆ Rapid charging with the BC-160

The BC-160 provides rapid charging of optional Li-Ion battery packs.

- An AC adapter (may be supplied with BC-160 depending on version) or the DC power cable (OPC-515L/CP-17L) is additionally required.

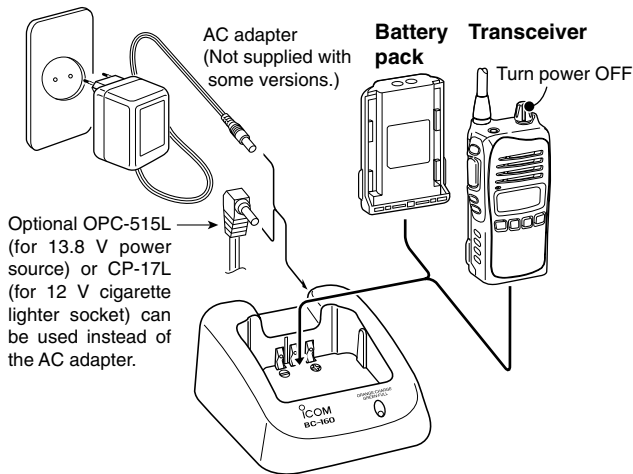

◆ AD-106 installation

- ① Install the AD-106 desktop charger adapter into the holder space of the BC-119N/BC-121N.
- ② Connect the plugs of the BC-119N/BC-121N to the AD-106 desktop charger adapter with the connector, then install the adapter into the charger with the supplied screws.

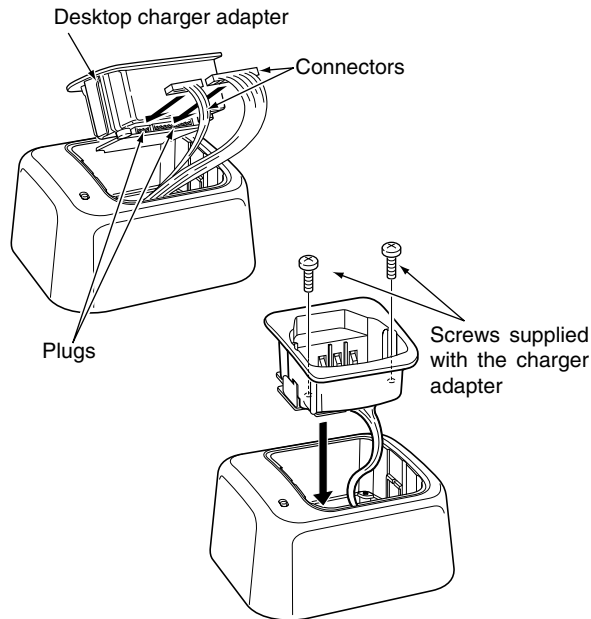

◆ **Rapid charging with the BC-119N+AD-106**

The optional BC-119N provides rapid charging of battery packs. The following items are additionally required.

- AD-106 charger adapter
- An AC adapter (may be supplied with BC-119N depending on version) or the DC power cable (OPC-515L/CP-17L).

- ① Insert the battery pack with/without the transceiver into the charger.
 - The charge indicator lights green.
- ② Charge the battery pack approx. 2 hours, depending on the remaining power condition.

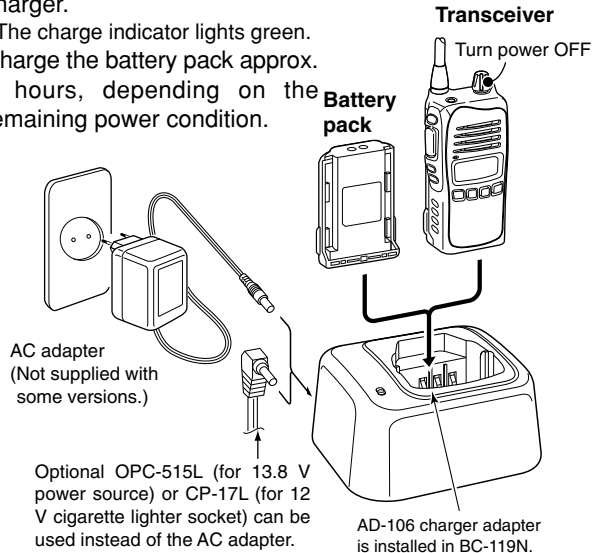

◆ **Rapid charging with the BC-121N+AD-106**

The optional BC-121N allows up to 6 battery packs to be charged simultaneously. The following items are additionally required.

- Six AD-106 charger adapters
- An AC adapter (BC-157) or the DC power cable (OPC-656)

- ① Insert the battery pack with/without the transceiver into the charger.
 - The charge indicator lights green.
- ② Charge the battery pack approx. 2 hours, depending on the remaining power condition.

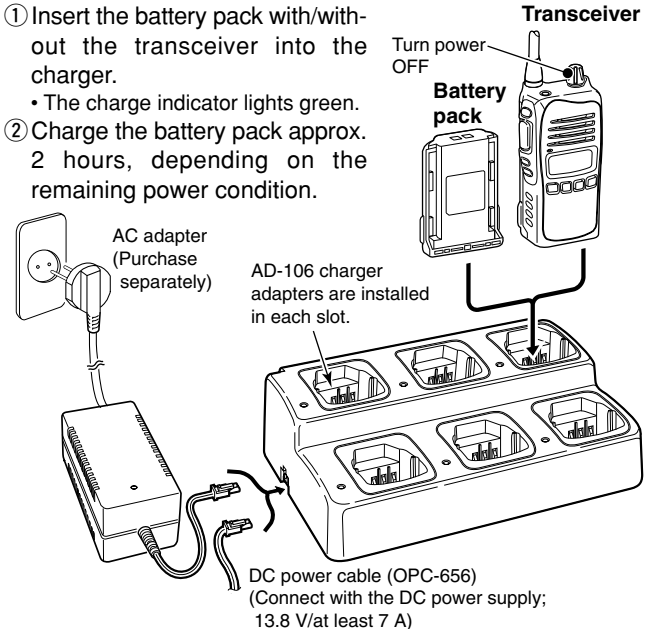

9 BATTERY CHARGING

IMPORTANT!: Battery charging

Ensure the guide lobs on the battery pack are correctly aligned with the guide rails inside the charger adapter.
(This illustration is described showing the BC-160.)

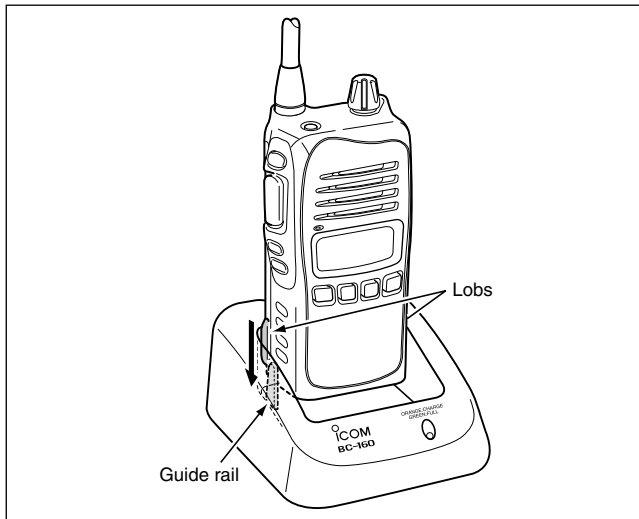

■ Optional battery case (BP-240)

When using the optional battery case, install 6 × AAA (LR03) size alkaline batteries as illustrated at right.

- ① Unhook the battery cover release hook (①), and open the cover in the direction of the arrow (②). (Fig.1)
- ② Then, install 6 × AAA (LR03) size alkaline batteries. (Fig.2)
 - Install the alkaline batteries only.
 - Be sure to observe the correct polarity.
 - Do not pin the ribbon under the batteries.
- ③ Fit the cover in the direction of the arrow (③), then close (④). And hook the battery cover release hook until it makes a 'click' sound (⑤). (Fig.3)

Fig.1

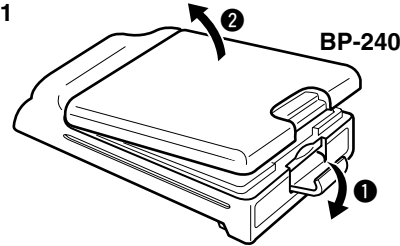

Fig.2

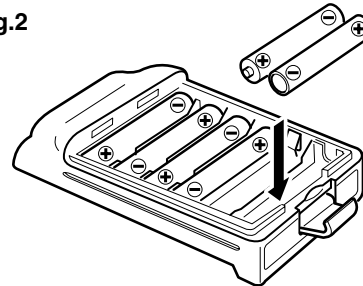
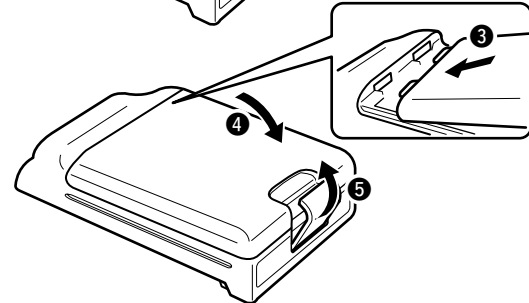

Fig.3



CAUTION:

- When installing batteries, make sure they are all the same brand, type and capacity. Also, do not mix new and old batteries together.
- Keep battery contacts clean. It's a good idea to clean battery terminals once a week.
- Never incinerate used battery cells since internal battery gas may cause them to rupture.
- Never expose a detached battery case to water. If the battery case gets wet, be sure to wipe it dry before using it.

NOTE: When the optional battery case is attached, the battery type must be selected to "DRY BATT" when turning the transceiver ON. (p. 11)

11 SWIVEL BELT CLIP

■ MB-93 contents

	Qty.
① Belt clip	1
② Base clip	1

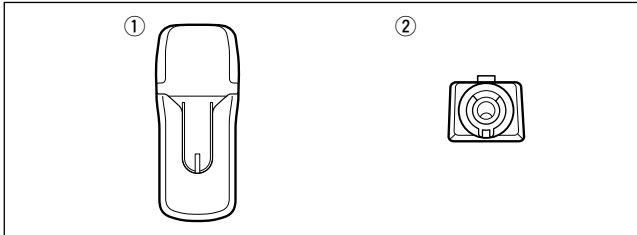

■ To attach

- ① Release the battery pack if it is attached. (p. 1)
- ② Slide the base clip in the direction of the arrow until the base clip is locked and makes a 'click' sound.

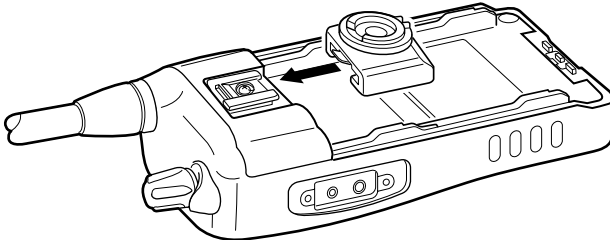

- ③ Clip the belt clip to a part of your belt. And insert the transceiver into the belt clip until the base clip inserted fully into the groove.

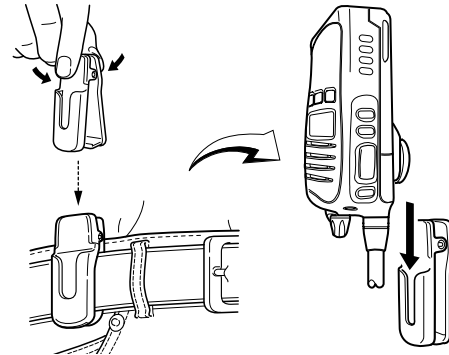

- ④ Once the transceiver is locked in place, it swivels as illustrated below.

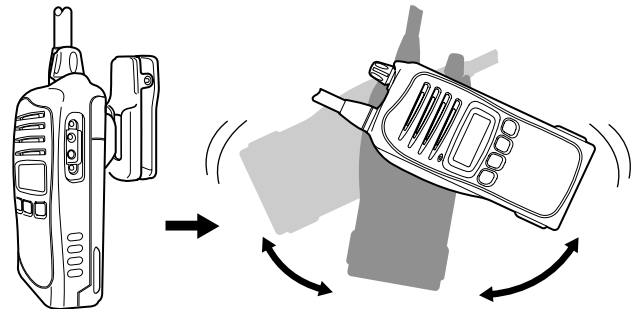

Once the transceiver is locked in place, it will swivel 360 degrees.

■ To detach

- ① Turn the transceiver upside down in the direction of the arrow and pull out from the belt clip.

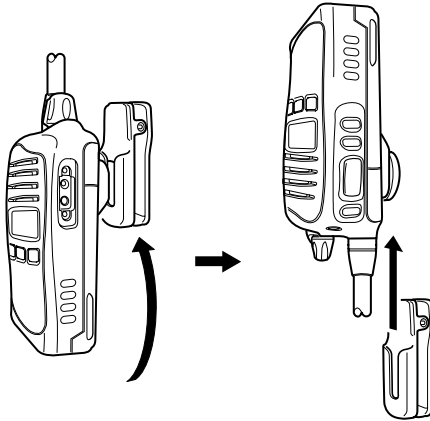

- ② Release the battery pack if it is attached. (p. 1)
- ③ Pinch the clip (①), and slide the base clip in the direction of the arrow (②).

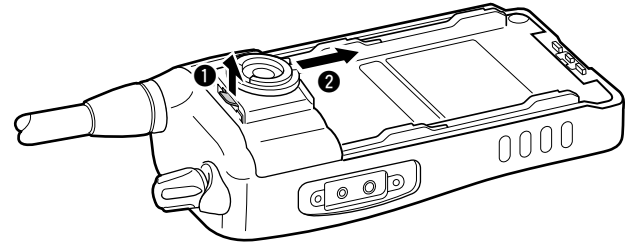

CAUTION!
HOLD THE TRANSCEIVER TIGHTLY, WHEN HANGING OR DETACHING THE TRANSCEIVER FROM THE BELT CLIP.
Otherwise the transceiver may not be attached to the holder or swivel properly if the transceiver is accidentally dropped and the base clip is scratched or damaged.

12 SPECIFICATIONS

■ Specifications

◇ General

- Frequency coverage
 - Analog : 446.00625–446.09375 MHz
 - Digital : 446.103125–446.196875 MHz
- Mode : 16K0G3E (FM)
14K0F3E (FM)
8K50F3E (FM)
4K00F1D (FM)
- Current drain (at 7.2 V) : TX high 0.5 A max.
Max. audio 350 mA max.
- Power supply requirement : 7.2 V DC nominal
(negative ground)
- Frequency stability : ± 0.5 kHz
(-25°C to $+55^{\circ}\text{C}$)
- Antenna impedance : 50 Ω nominal
- Dimensions : 53.0(W) \times 195.0(H) \times 32.5(D) mm
(Projections not included)
- Weight : Approx. 280 g

◇ Transmitter

- Output power : 0.5 W
- Modulation system : Variable reactance frequency
modulation
- Max. frequency deviation : ± 2.5 kHz
- Spurious emissions : 0.25 μW or below 1 GHz
1.00 μW above 1 GHz
- Adjacent channel power : 60 dB
- External mic. connector : 3-conductor 2.5 (d) mm/2.2 k Ω

◇ Receiver

- Receive system : Double conversion
superheterodyne
- Sensitivity (20 dB SINAD) : 26.5 dB $\mu\text{V}/\text{m}$
- Squelch sensitivity : 26.5 dB $\mu\text{V}/\text{m}$
- Intermodulation rejection ratio : 86.29 dB $\mu\text{V}/\text{m}$
- Spurious response rejection ratio : 91.29 dB $\mu\text{V}/\text{m}$
- Adjacent channel selectivity : 81.29 dB $\mu\text{V}/\text{m}$
- Audio output power : 0.5 W (typical) at 5% distortion
with a 8 Ω load
0.6 W (typical) at 5% distortion
with a 6 Ω load
- External speaker connector : 2-conductor 3.5 (d) mm/8 Ω

All stated specifications are subject to change without notice or obligation.

■ Channel frequency lists

Channel	Zone 1 (Analog mode)		Zone 2 (Analog mode)	
	Frequency (MHz) ^{*1}	Tone (Hz) ^{*2}	Frequency (MHz) ^{*1}	Tone (Hz) ^{*2}
1	446.006250	No setting	446.006250	94.8
2	446.018750	No setting	446.093750	88.5
3	446.031250	No setting	446.031250	103.5
4	446.043750	107.2	446.068750	79.7
5	446.056250	110.9	446.043750	118.8
6	446.068750	114.8	446.018750	123.0
7	446.081250	118.8	446.081250	127.3
8	446.093750	123.0	446.056250	85.4
9	446.006250	127.3	446.006250	107.2
10	446.018750	131.8	446.093750	110.9
11	446.031250	136.5	446.031250	114.8
12	446.043750	141.3	446.068750	82.5
13	446.056250	146.2	446.043750	132N
14	446.068750	151.4	446.018750	155N
15	446.081250	156.7	446.056250	134N
16	—	—	446.081250	243N

*1 All operating channel frequencies are fixed.

*2 CTCSS tone frequencies can be programmed by manually. (p. 16)

You can use DTCS (Digital Tone Code Squelch) instead of CTCSS. (p. 17)

12 SPECIFICATIONS

■ Channel frequency lists (Continued)

Channel	Zone 3 (Analog mode)		Zone 4 (Digital mode)	
	Frequency (MHz) ^{*1}	Tone (Hz) ^{*2}	Frequency (MHz) ^{*1}	Common ID ^{*3}
1	446.006250	67.0	446.103125	85
2	446.018750	71.9	446.109375	87
3	446.031250	74.4	446.115625	93
4	446.043750	77.0	446.121875	95
5	446.056250	79.7	446.128125	117
6	446.068750	82.5	446.134375	119
7	446.081250	85.4	446.140625	125
8	446.093750	88.5	446.146875	127
9	—	—	446.153125	213
10	—	—	446.159375	215
11	—	—	446.165625	221
12	—	—	446.171875	223
13	—	—	446.178125	245
14	—	—	446.184375	247
15	—	—	446.190625	253
16	—	—	446.196875	254

^{*1} All operating channel frequencies are fixed.

^{*2} CTCSS tone frequencies can be programmed by manually. (p. 16)

You can use DTCS (Digital Tone Code Squelch) instead of CTCSS. (p. 17)

^{*3} Common ID can be programmed by manually. (p. 19)

◇ BATTERY PACK

Battery pack	Voltage	Capacity	Battery life*1	
BP-231	7.4 V	1150 mAh	Analog mode	10.4 hrs.
			Digital mode	8 hrs.
BP-232	7.4 V	2000 mAh	Analog mode	18 hrs.
			Digital mode	14 hrs.
BP-240	Battery case for AAA (LR03) × 6 alkaline		— *2	

*1 Operating periods are calculated under the following conditions;
TX : RX : standby = 5 : 5 : 90

*2 Operating period depends on the alkaline cells used.

◇ CHARGERS

• **BC-119N** DESKTOP CHARGER + **AD-106** CHARGER ADAPTER
+ **BC-145** AC ADAPTER

For rapid charging of battery packs. An AC adapter is supplied with the charger depending on versions. Charging time: approx. 2 hours when BP-231 is attached.

• **BC-121N** MULTI-CHARGER + **AD-106** CHARGER ADAPTER (6 pcs.)
+ **BC-157** AC ADAPTER

For rapid charging of up to 6 battery packs (six AD-106's are required) simultaneously. An AC adapter should be purchased separately. Charging time: approx. 2 hours when BP-231 is attached.

• **BC-160** DESKTOP CHARGER + **BC-145** AC ADAPTER

For rapid charging of battery packs. The same as supplied with the transceiver. An AC adapter is supplied with the charger depending on versions. Charging time: approx. 2 hours when BP-231 is attached.

◇ BELT CLIPS

- **MB-93** SWIVEL BELT CLIP
- **MB-94** BELT CLIP
The same as supplied with the transceiver.
- **MB-96N/96F** LEATHER BELT HANGER

◇ DC CABLES

- **CP-17L** CIGARETTE LIGHTER CABLE
Allows charging of the battery pack through a 12 V cigarette lighter socket. (For BC-119N)
- **OPC-515L/OPC-656** DC POWER CABLES
Allows charging of the battery pack using a 13.8 V power source instead of the AC adapter.
OPC-515L: For BC-119N
OPC-656 : For BC-121N

◇ OTHER OPTIONS

- **SP-13** EARPHONE
Provides clear receive audio in noisy environment.
- **HM-158L/159L** SPEAKER-MICROPHONE
Combination speaker-microphone that provides convenient operation while hanging the transceiver from your belt.
- **HS-94/HS-95/HS-97** HEADSET + **VS-1L** VOX/PTT CASE
HS-94: Ear-hook type
HS-95: Neck-arm type
HS-97: Throat microphone
VS-1L: VOX/PTT switch box for hands-free operation, etc.

Some options may not available in some countries. Please ask your dealer for details.



CE versions of the IC-F4029SDR which display the “CE” symbol on the serial number seal, comply with the essential requirements of the European Radio and Telecommunication Terminal Directive 1999/5/EC.



This warning symbol indicates that this equipment operates in non-harmonised frequency bands and/or may be subject to licensing conditions in the country of use. Be sure to check that you have the correct version of this radio or the correct programming of this radio, to comply with national licensing requirement.



**DECLARATION
OF CONFORMITY**

We Icom Inc. Japan
1-1-32, Kamiminami, Hirano-ku
Osaka 547-0003, Japan

CE0168

Declare on our sole responsibility that this equipment complies with the essential requirements of the Radio and Telecommunications Terminal Equipment Directive, 1999/5/EC, and that any applicable Essential Test Suite measurements have been performed.

Düsseldorf 1st Feb. 2006
Place and date of issue

Kind of equipment: UHF PMR TRANSCEIVER

Icom (Europe) GmbH
Himmelgeister straÙe 100
D-40225 Düsseldorf

Type-designation: IC-F4029SDR

Authorized representative name

Version (where applicable):

H. Ikegami
General Manager

This compliance is based on conformity with the following harmonised standards, specifications or documents:

- i) EN 60950-1 2001
- ii) EN 300 296-2 (March 2001)
- iii) EN 301 489-1 V1.4.1 (August 2002)
- iv) EN 301 489-5 V1.3.1 (August 2002)
- v) EN 301 166-2 V1.1.1 (December 2001)
- vi) _____
- vii) _____

Signature

Icom Inc.

15 ABOUT VOICE CODING TECHNOLOGY

The AMBE+2™ voice coding Technology embodied in this product is protected by intellectual property rights including patent rights, copyrights and trade secrets of Digital Voice Systems, Inc. This voice coding Technology is licensed solely for use within this Communications Equipment. The user of this Technology is explicitly prohibited from attempting to extract, remove, decompile, reverse engineer, or disassemble the Object Code, or in any other way convert the Object Code into a human-readable form. U.S. Patent Nos. #5,870,405, #5,826,222, #5,754,974, #5,701,390, #5,715,365, #5,649,050, #5,630,011, #5,581,656, #5,517,511, #5,491,772, #5,247,579, #5,226,084 and #5,195,166.

Count on us!

< Intended Country of Use >

- GER FRA ESP SWE
 AUT NED POR DEN
 GBR BEL ITA FIN
 IRL LUX GRE SUI
 NOR